

IL 255
11/16 x 2 1/4

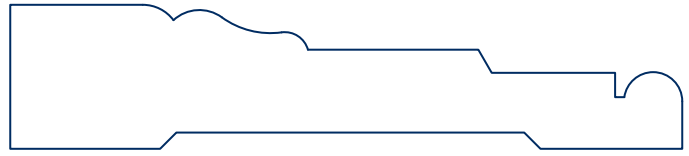

IL 227
3/4 x 3 1/2

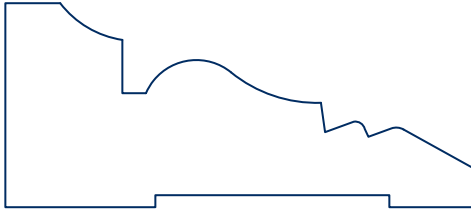

IL 254
1 1/16 x 2 7/16



IL 288
3/4 x 3 1/2

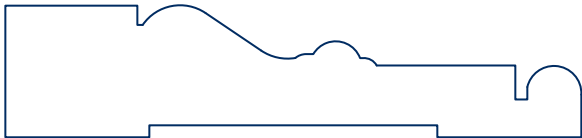

IL 242
11/16 x 3

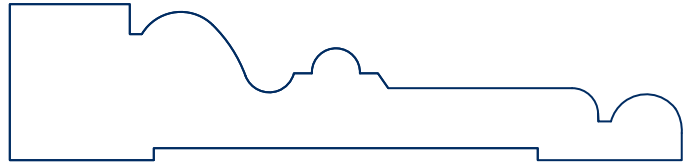

IL 201
13/16 x 3 1/2

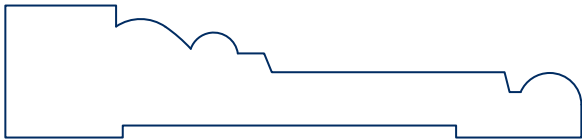

IL 207
11/16 x 3

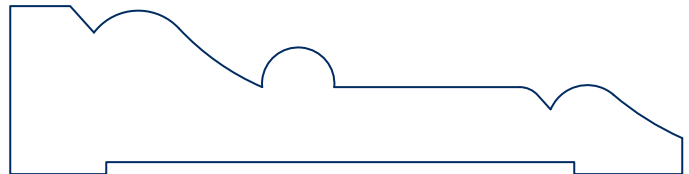

IL 214
7/8 x 3 1/2

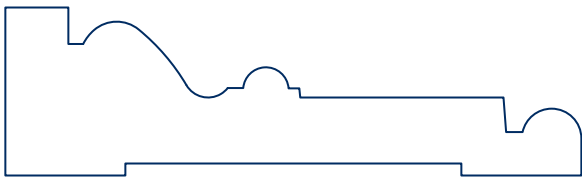

IL 246
7/8 x 3

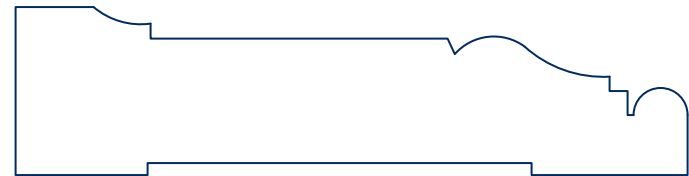

IL 241
7/8 x 3 1/2

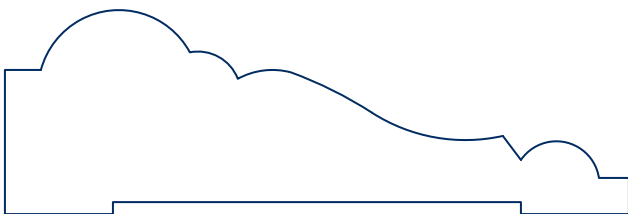

IL 236
1 1/16 x 3 1/4

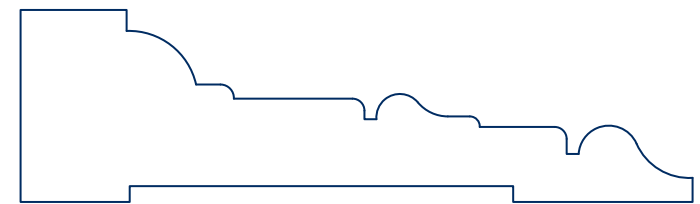

IL 204
1 x 3 1/2

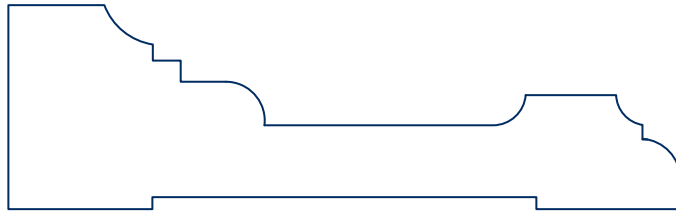

IL 202
1 1/16 x 3 1/2

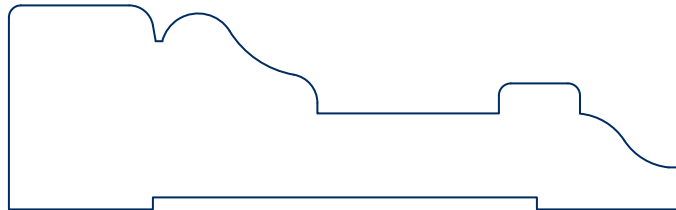

IL 244
1 1/16 x 3 1/2

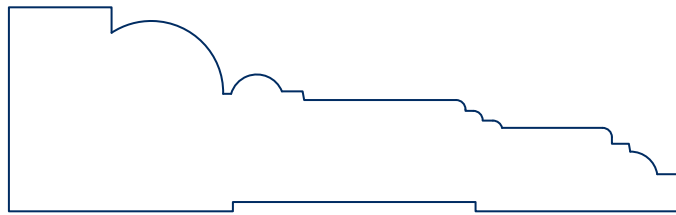

IL 289
1 1/16 x 3 1/2  p.32

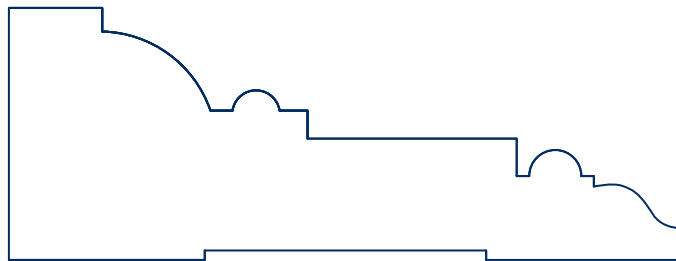

IL 290
1 5/16 x 3 1/2

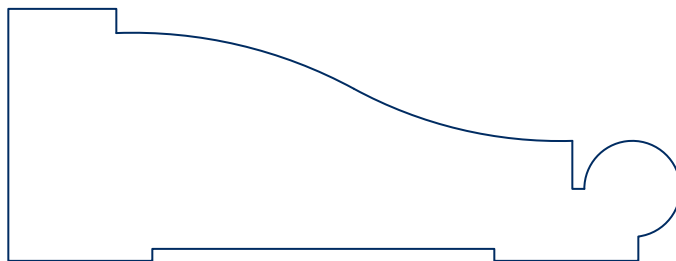

IL 234
1 5/16 x 3 1/2

Profiles Shown 1:1



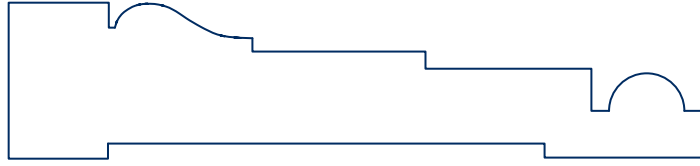

IL 239
13/16 x 3 5/8

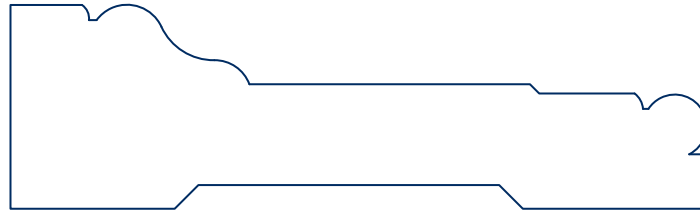

IL 225
1 1/16 x 3 5/8

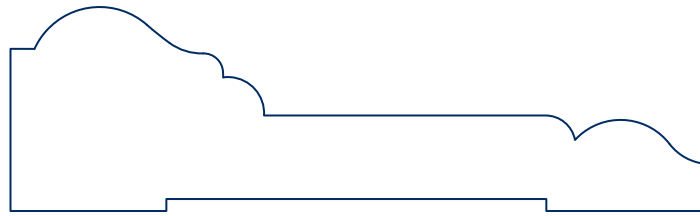

IL 238
1 1/16 x 3 5/8

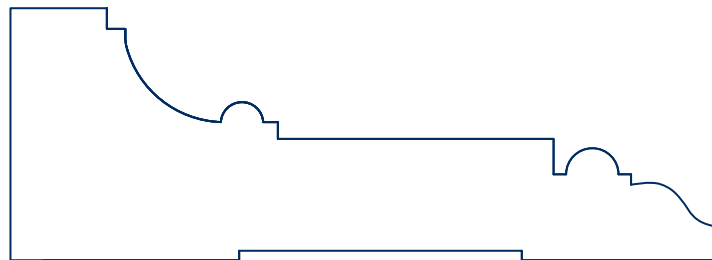

IL 291
1 5/16 x 3 11/16

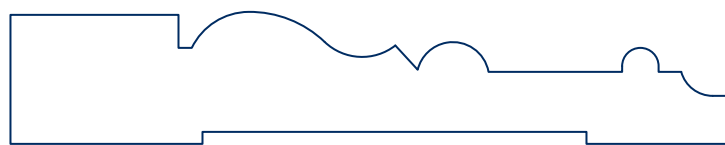

IL 213
11/16 x 3 3/4



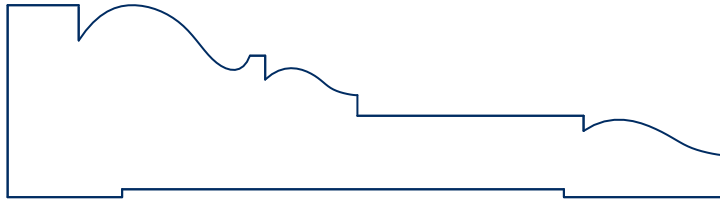

IL 292
1 x 3 3/4

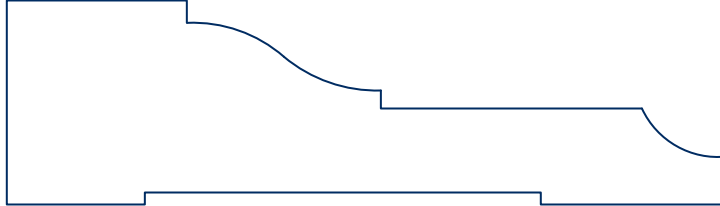

IL 232
1 1/16 x 3 3/4

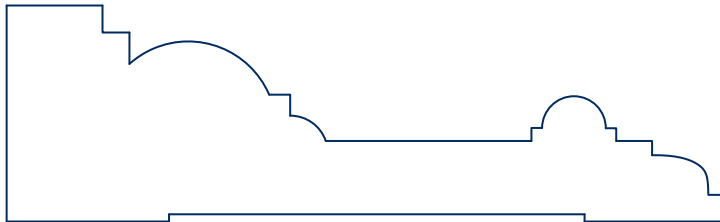

IL 293
1 1/8 x 3 3/4

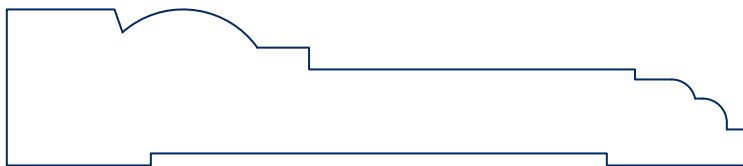

IL 217
13/16 x 3 7/8

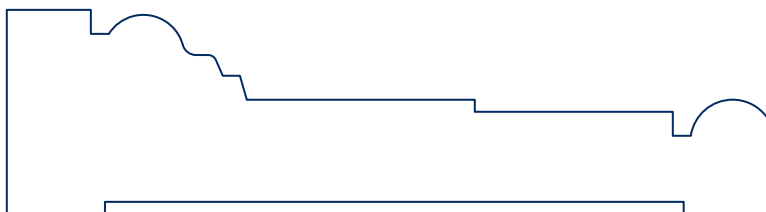

IL 240
1 1/16 x 4

Profiles Shown 1:1



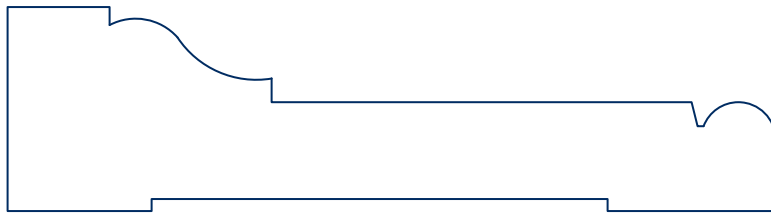

IL 223
1 1/16 x 4

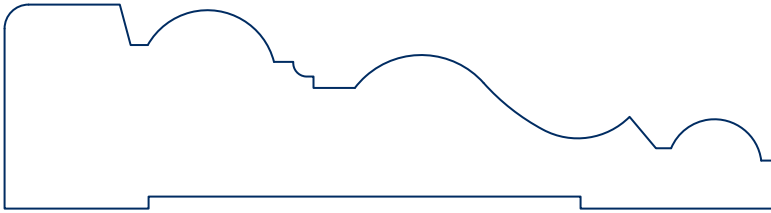

IL 205
1 1/16 x 4

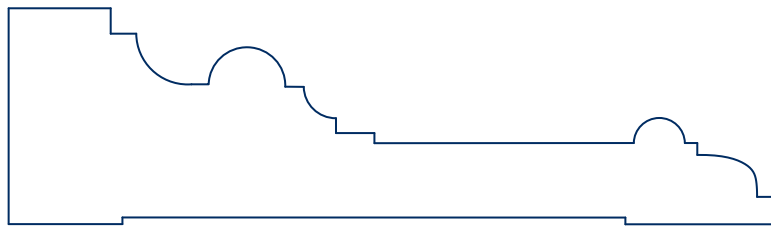

IL 294
1 1/8 x 4

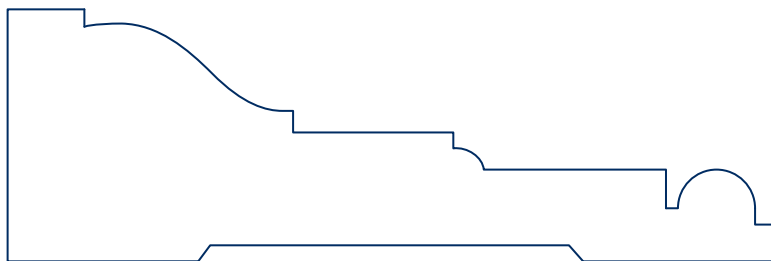

IL 295
1 5/16 x 4

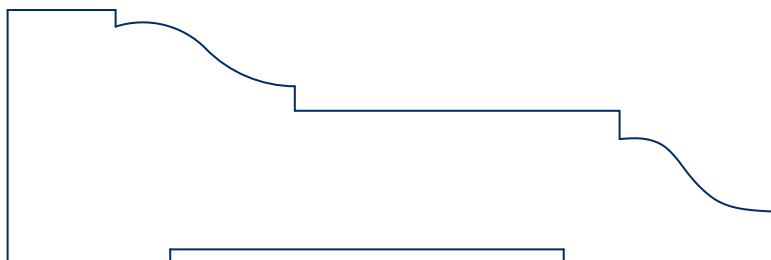

IL 296
1 5/16 x 4



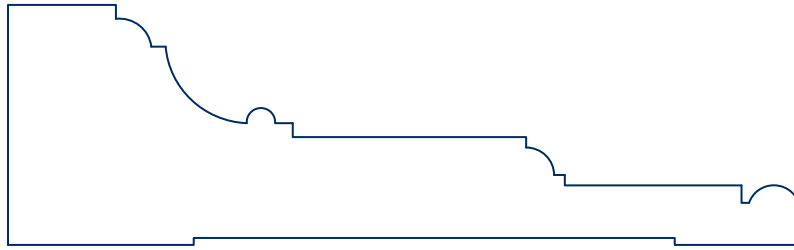

IL 297
1 1/4 x 4 1/8

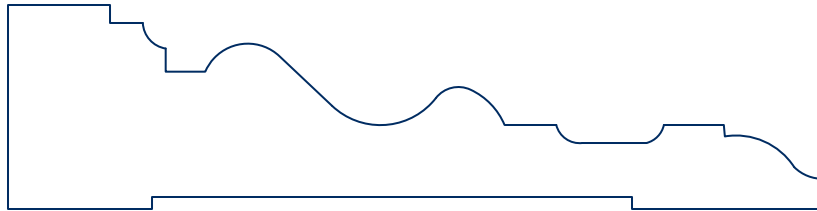

IL 203
1 1/16 x 4 1/4

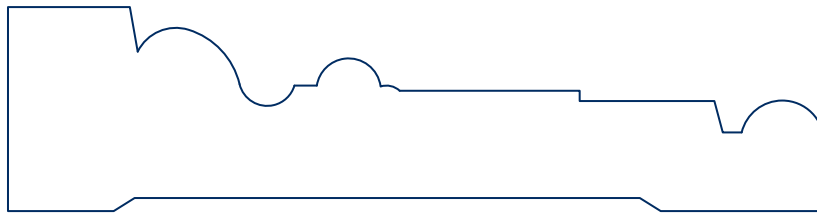

IL 224
1 1/16 x 4 1/4

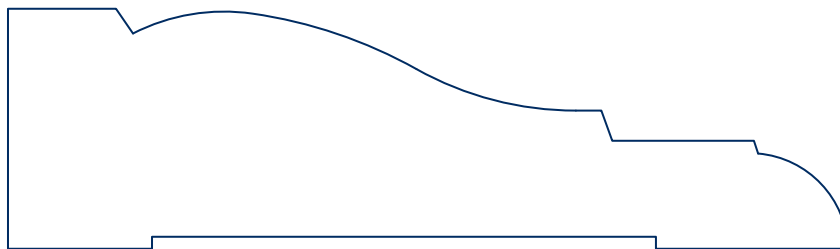

IL 250
1 1/4 x 4 3/8

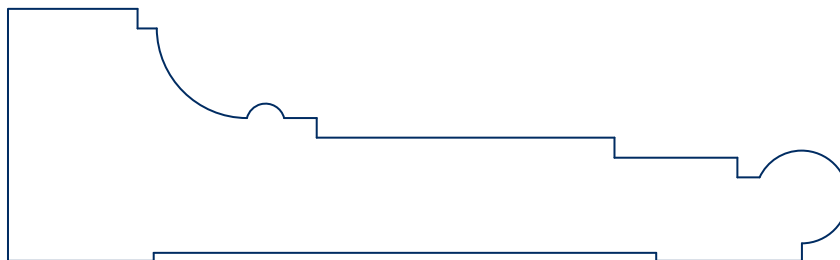

IL 298
1 5/16 x 4 3/8

Profiles Shown 1:1

Greenwich, CT
203.531.8050 914.939.2500

Bethel, CT
203.748.5629

Newtown, CT
203.364.0074

Stamford, CT
203.348.3761

Croton Falls, NY
914.277.3603

Shrub Oak, NY
914.245.5050



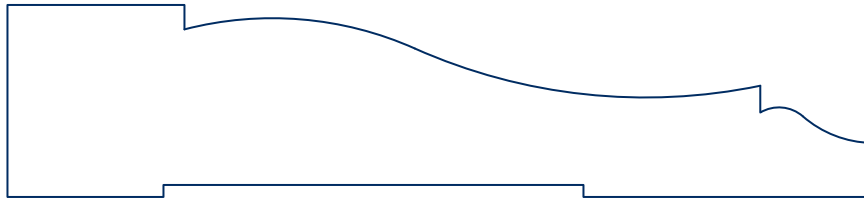

IL 218
1 x 4 1/2

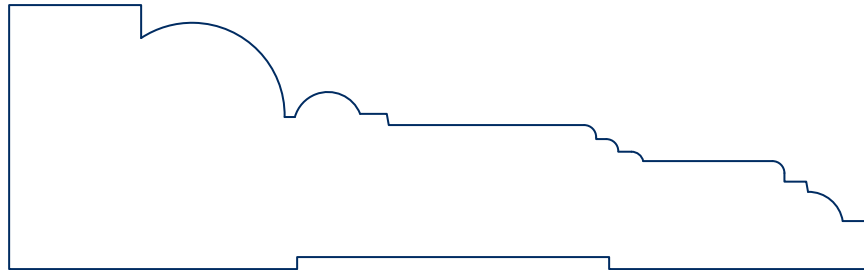

IL 219
1 3/8 x 4 1/2

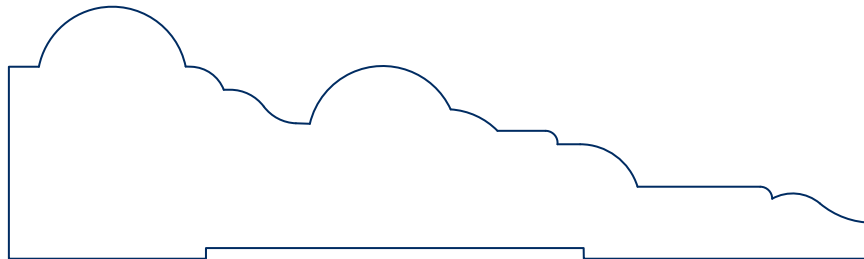

IL 212
1 5/16 x 4 1/2

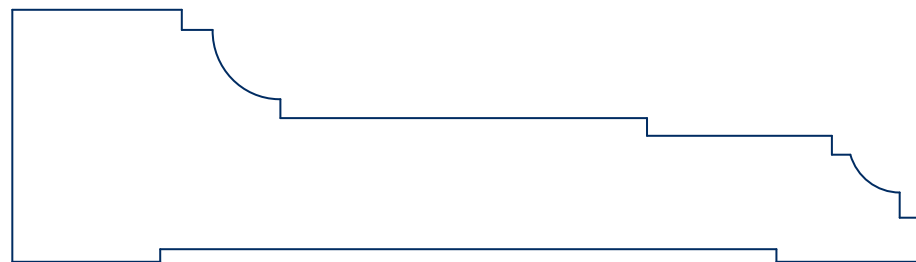

IL 299
1 5/16 x 4 3/4

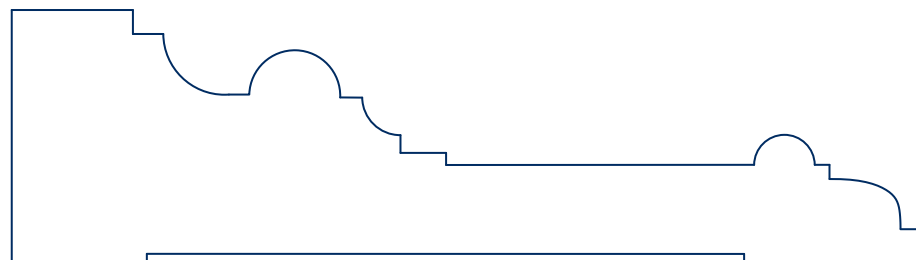

IL 2000
1 5/16 x 4 3/4



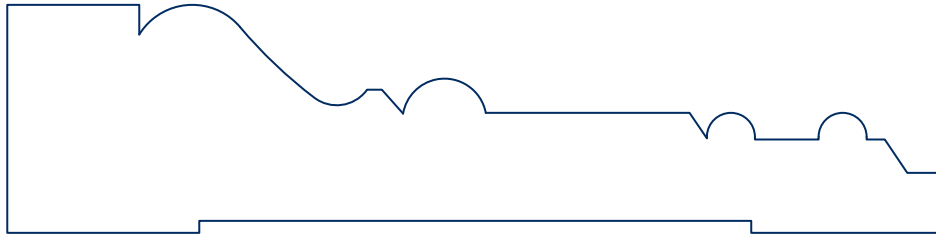

IL 220
1 3/16 x 4 7/8

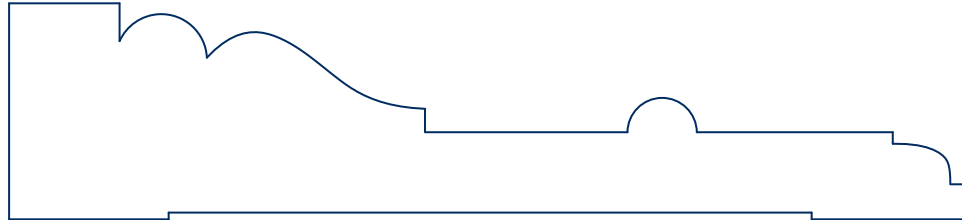

IL 2001
1 1/8 x 5

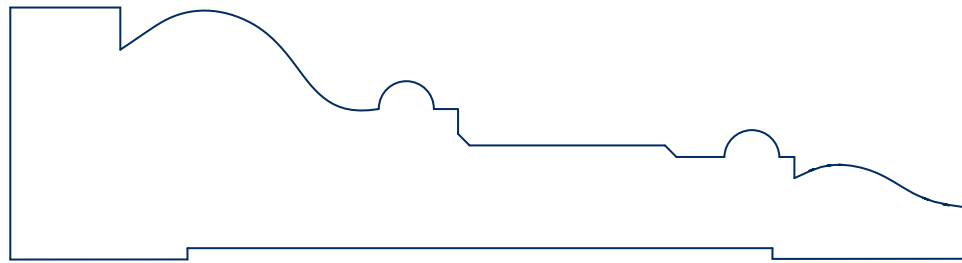

IL 2002
1 5/16 x 5

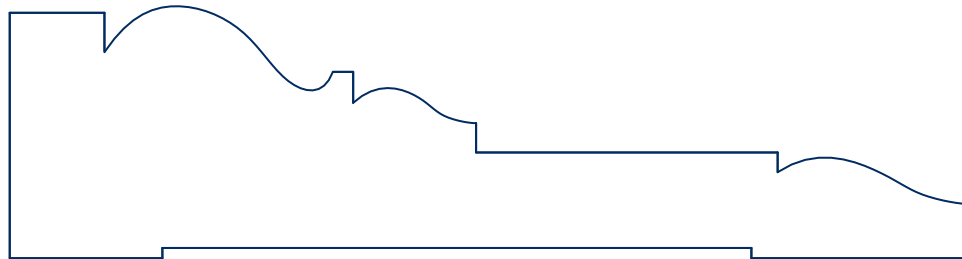

IL 2003
1 5/16 x 5

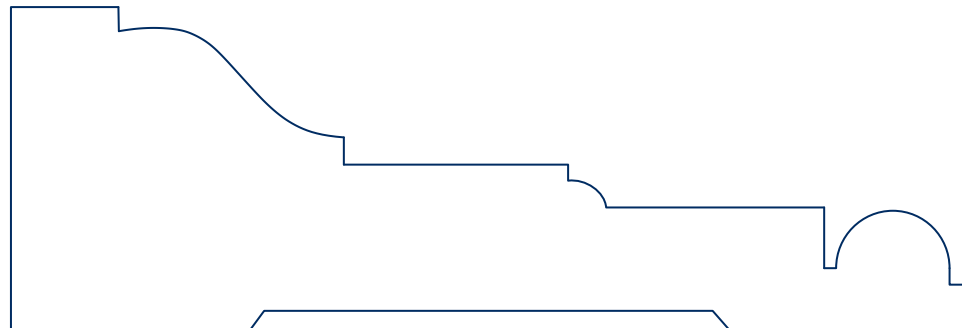

IL 2004
1 11/16 x 5

Profiles Shown 1:1

Greenwich, CT
203.531.8050 914.939.2500

Bethel, CT
203.748.5629

Newtown, CT
203.364.0074

Stamford, CT
203.348.3761

Croton Falls, NY
914.277.3603

Shrub Oak, NY
914.245.5050



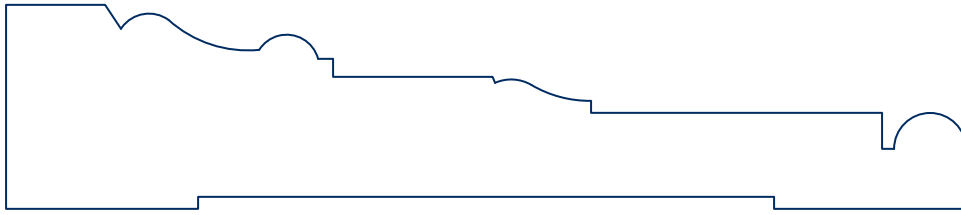

IL 228
1 1/16 x 5

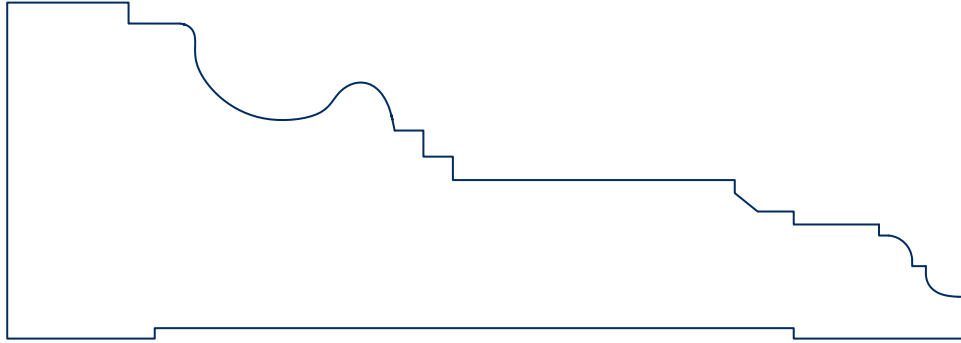

IL 2005
1 3/4 x 5



IL 287
3/4 x 5 1/2

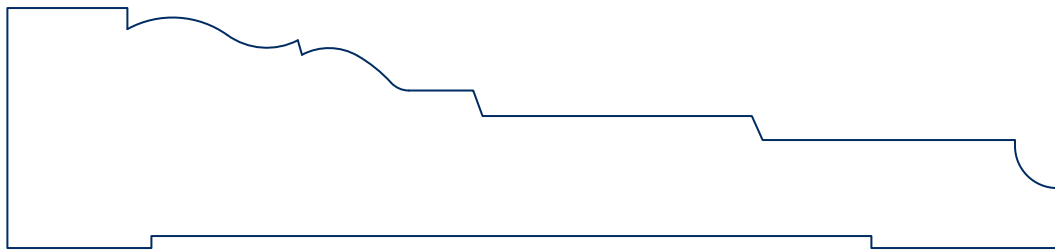

IL 221
1 1/4 x 5 1/2

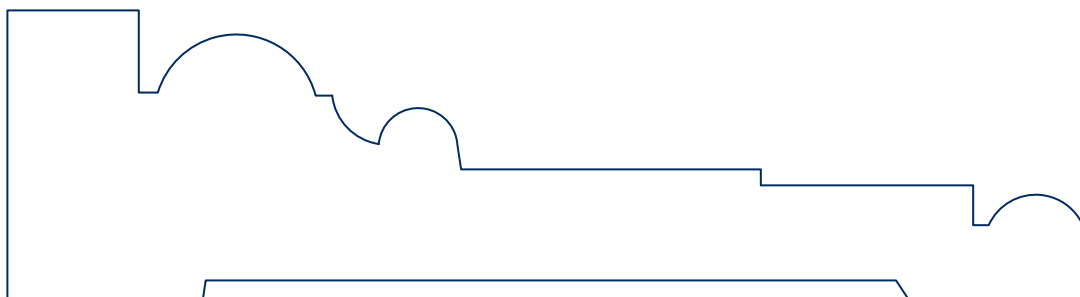

IL 282
1 1/2 x 5 5/8



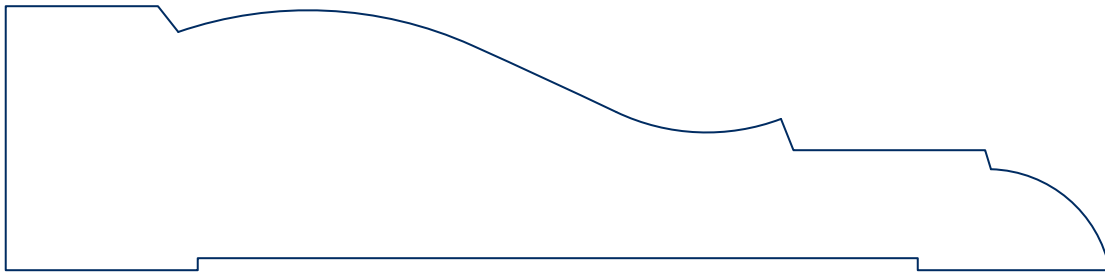

IL 251
1 3/8 x 5 3/4

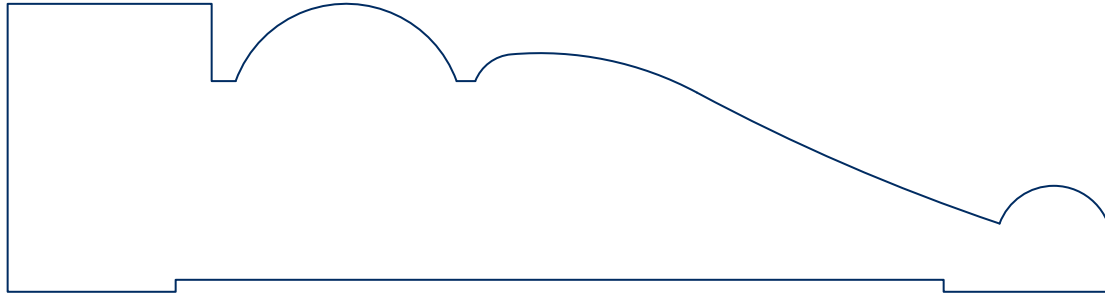

IL 260
1 1/2 x 5 3/4

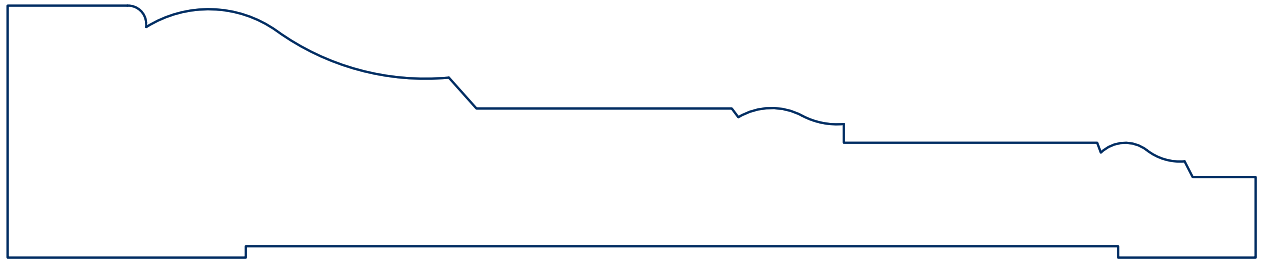

IL 222
1 5/16 x 6 1/2

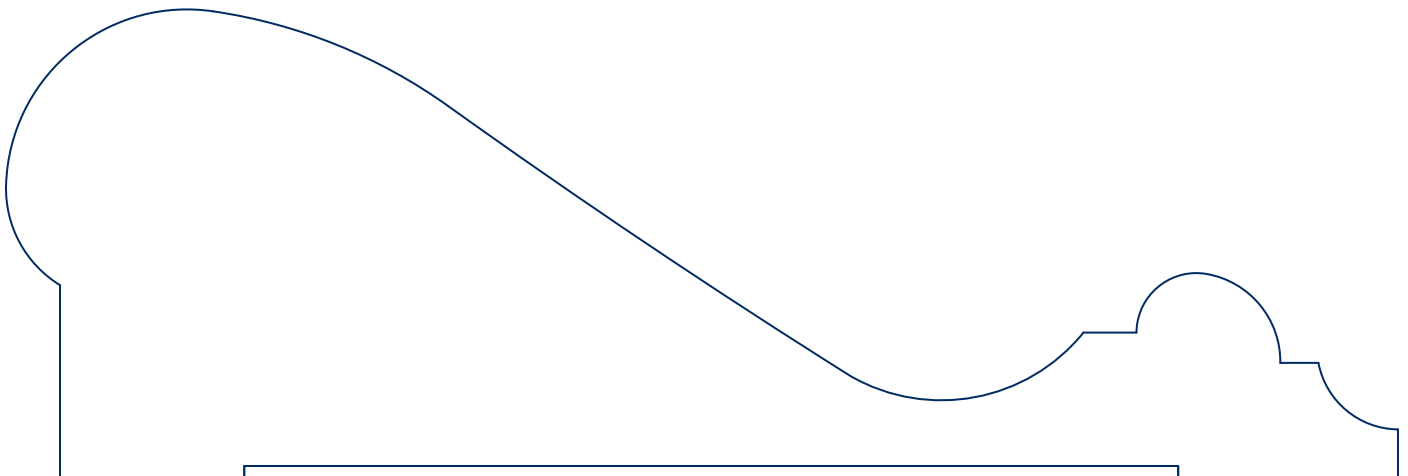

IL 252
2 7/16 x 7 1/4

Profiles Shown 1:1

Greenwich, CT
203.531.8050 914.939.2500

Bethel, CT
203.748.5629

Newtown, CT
203.364.0074

Stamford, CT
203.348.3761

Croton Falls, NY
914.277.3603

Shrub Oak, NY
914.245.5050



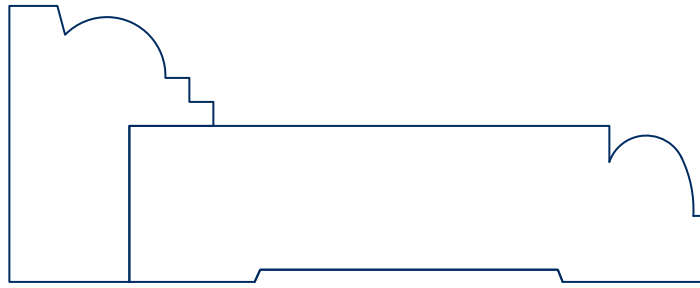

IL 233B IL 233 Overall Dimension = 3 5/8
 1 7/16 x 1 1/16 13/16 x 3

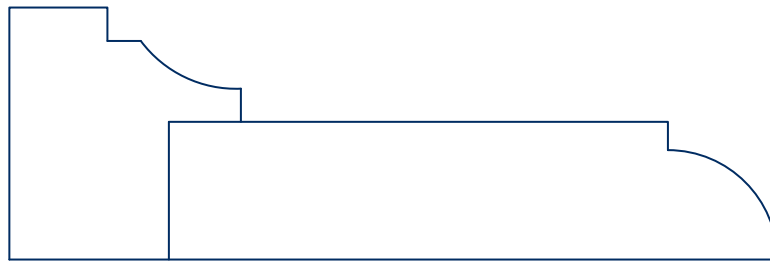

IL 2006B IL 2006 Overall Dimension = 4
 1 5/16 x 1 3/16 11/16 x 3 3/16

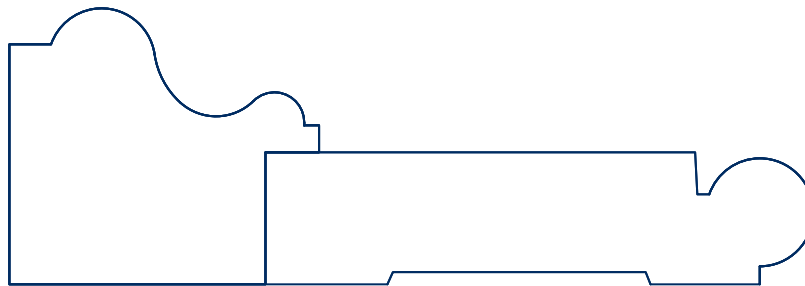

IL 226B IL 226 Overall Dimension = 4 3/16
 1 7/16 x 1 5/8 11/16 x 2 7/8

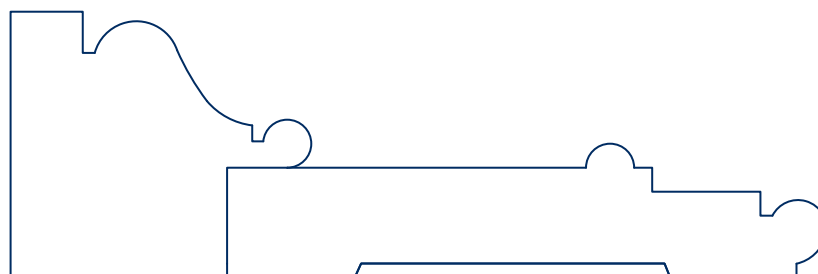

IL 230B IL 230 Overall Dimension = 4 1/4
 1 3/8 x 1 9/16 11/16 x 3 1/8



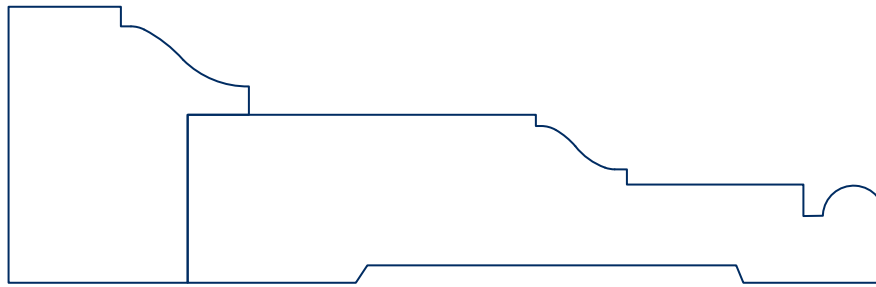

IL 285B
1 7/16 x 1 1/4

IL 285
7/8 x 3 5/8

Overall Dimension = 4 9/16

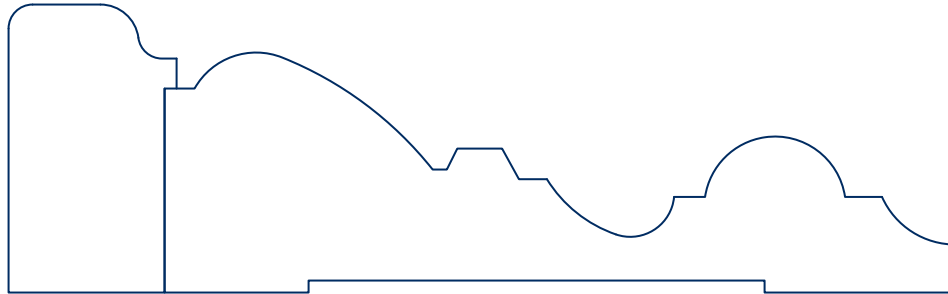

IL 206B
1 1/2 x 7/8

IL 206
1 1/4 x 4 1/8

Overall Dimension = 4 15/16

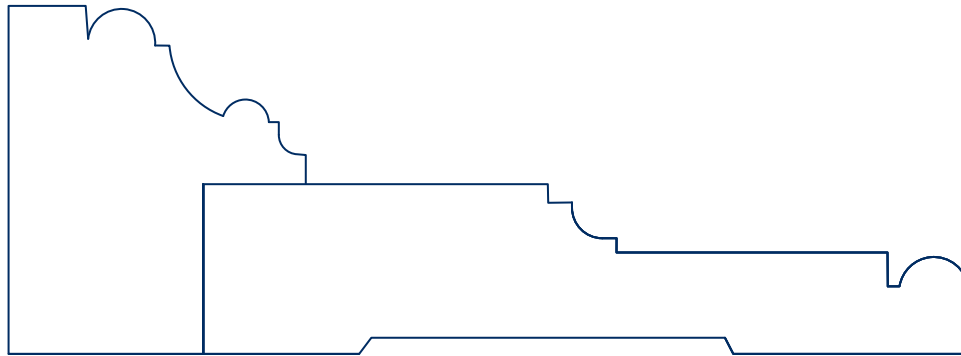

IL 284B
1 13/16 x 1 9/16

IL 284
7/8 x 4

Overall Dimension = 5

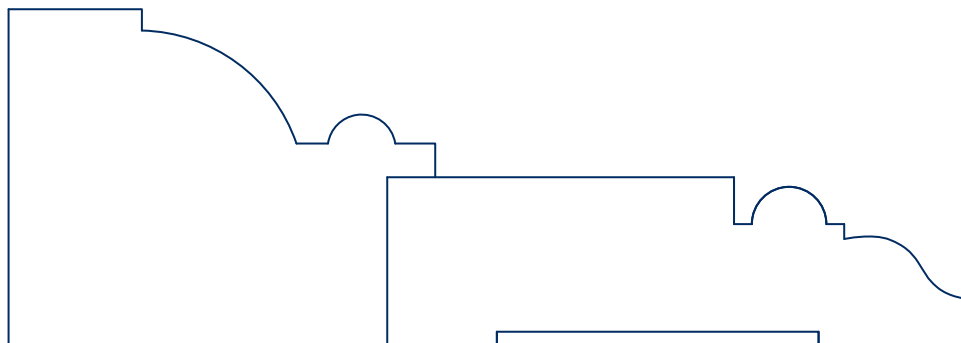

IL 2008B
1 3/4 x 2 1/4

IL 2008
7/8 x 3

Overall Dimension = 5

Profiles Shown 1:1



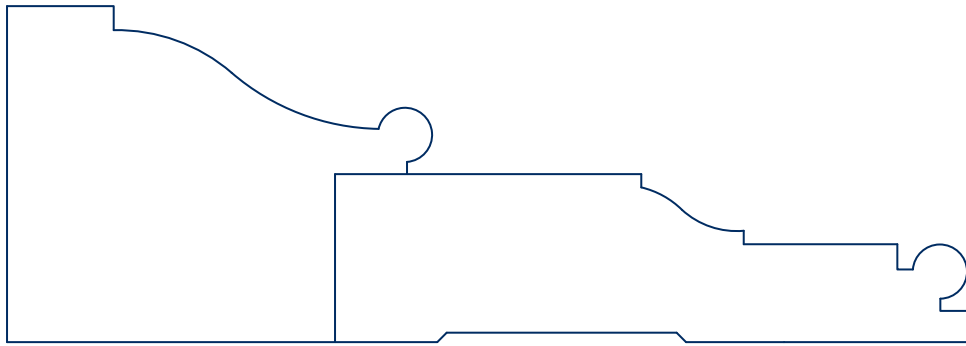

IL 2009B
1 3/4 x 2 3/16

IL 2009
7/8 x 3 5/16

Overall Dimension = 5

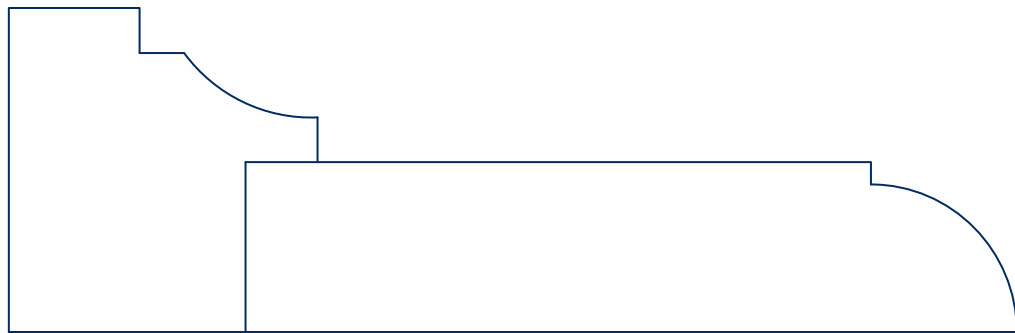

IL 2007B
1 11/16 x 1 5/8

IL 2007  p.32
7/8 x 4

Overall Dimension = 5 1/4

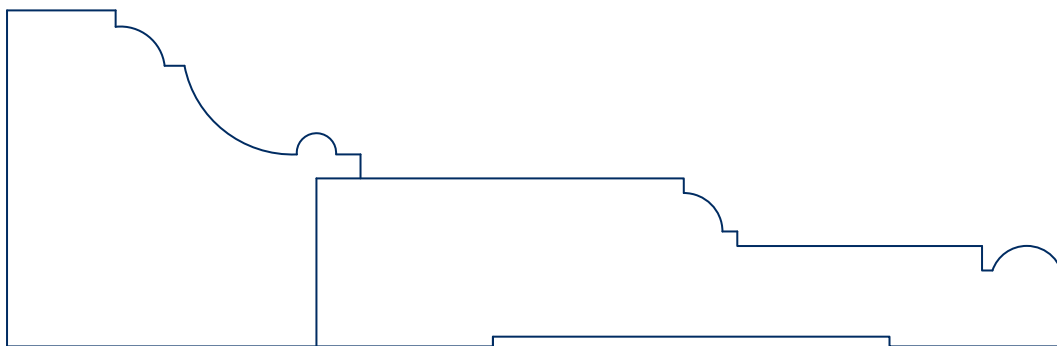

IL 2010B
1 3/4 x 1 13/16

IL 2010
7/8 x 3 7/8

Overall Dimension = 5 1/2

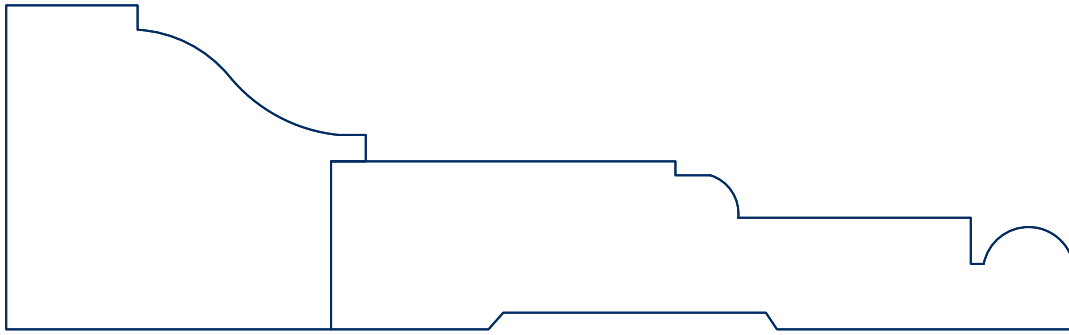

IL 283B
1 11/16 x 1 7/8

IL 283
7/8 x 3 7/8

Overall Dimension = 5 9/16

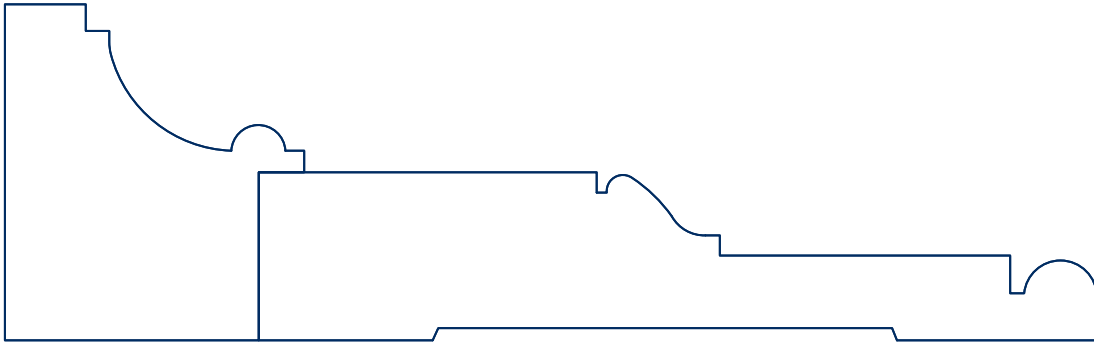

IL 286B
1 3/4 x 1 9/16

IL 286
7/8 x 4 3/8

Overall Dimension = 5 11/16

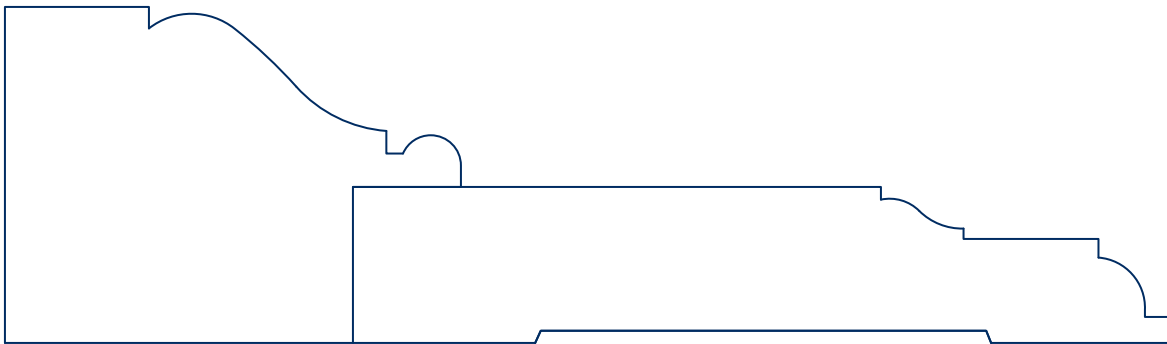

IL 259B
1 3/4 x 2 3/8

IL 259
13/16 x 4 1/4

Overall Dimension = 6 1/16

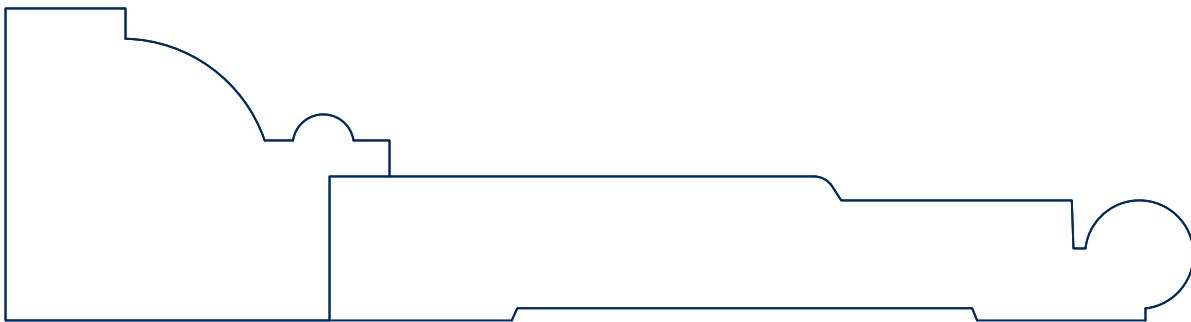

IL 229B
1 5/8 x 2

IL 229
3/4 x 4 1/2

Overall Dimension = 6 3/16

Profiles Shown 1:1



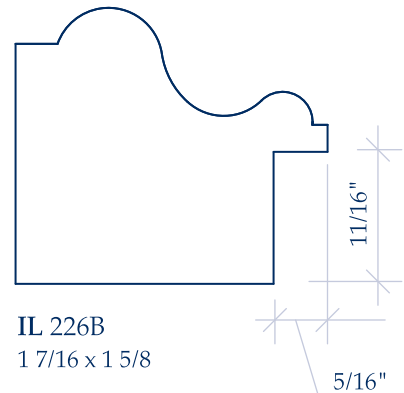
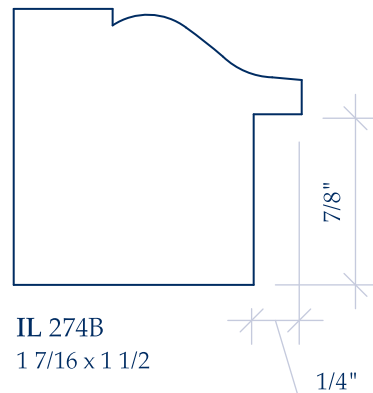
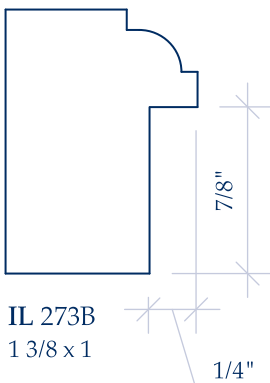
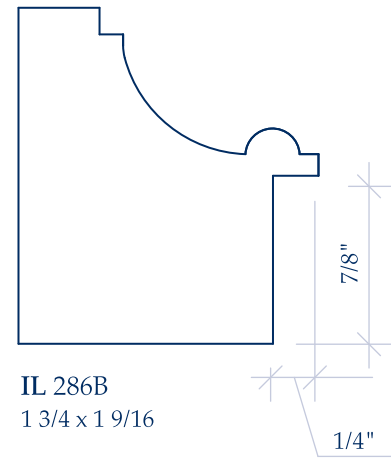
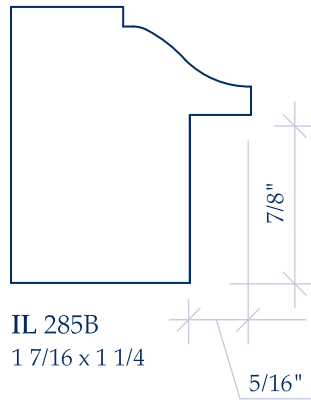
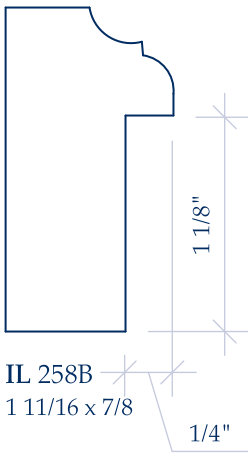
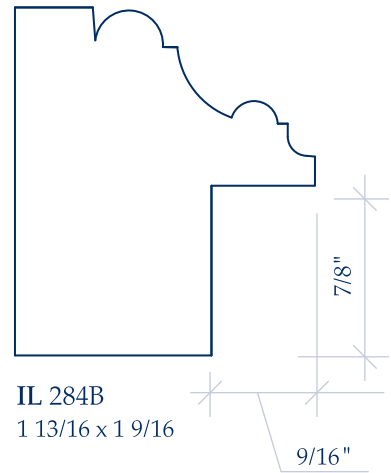
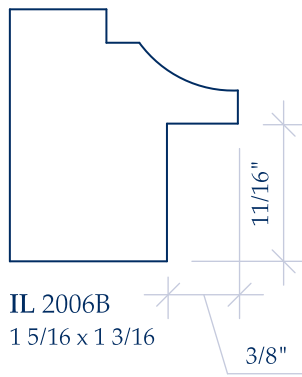
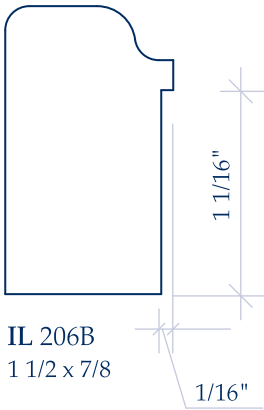
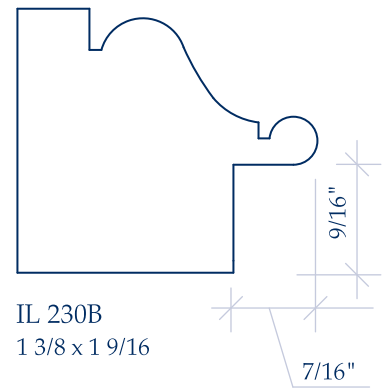
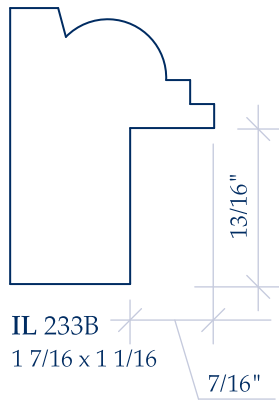
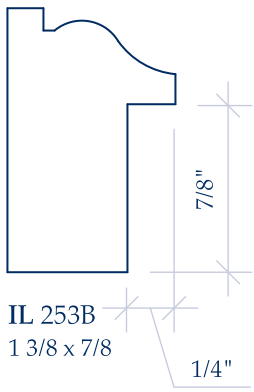

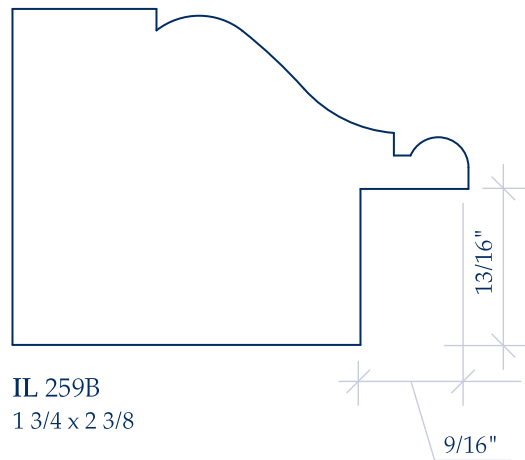
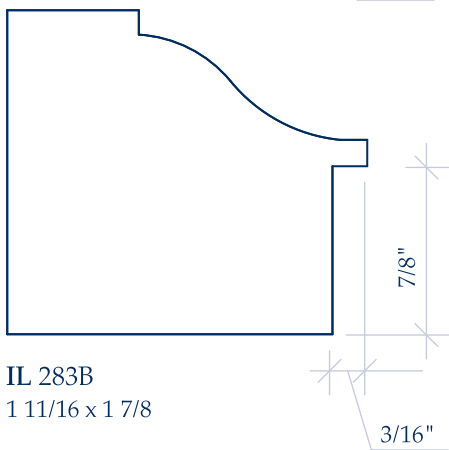
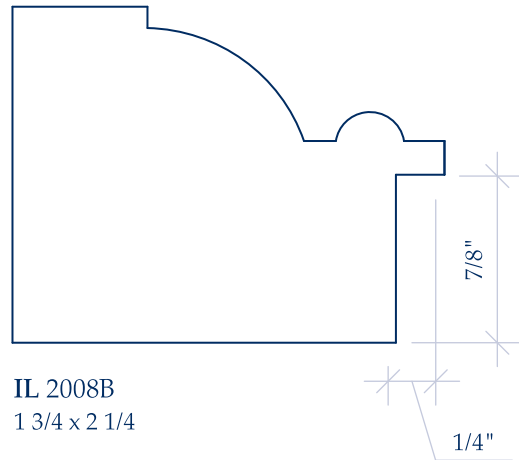
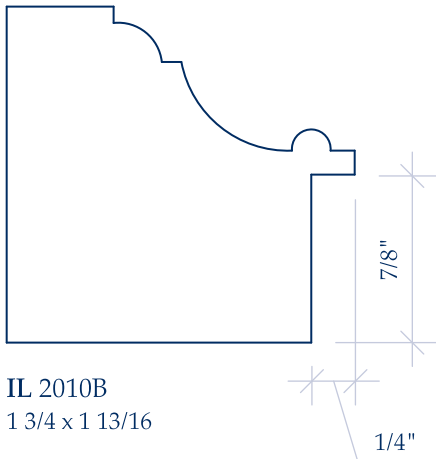
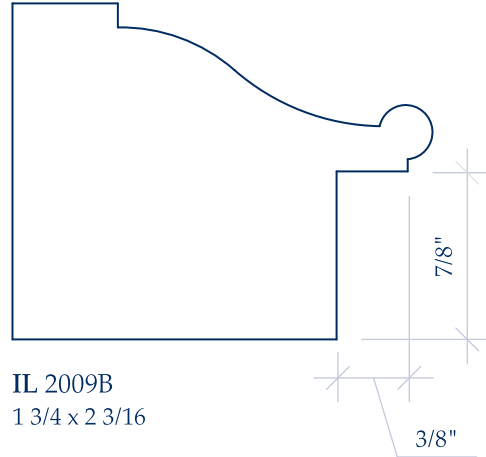
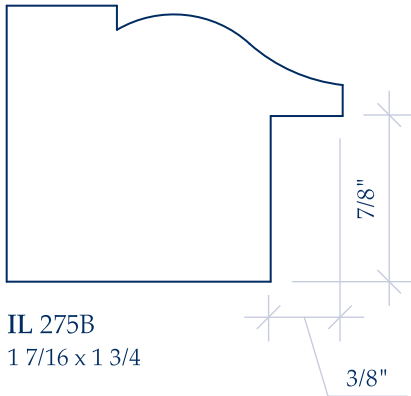
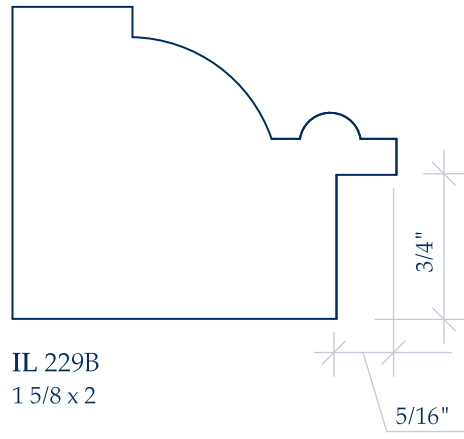
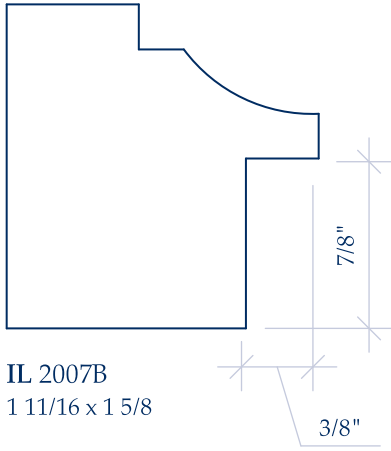

Profiles Shown 1:1





IL 269B
5/8 x 3/4



IL 277
3/4 x 2 3/4



IL 265B
3/4 x 3/4

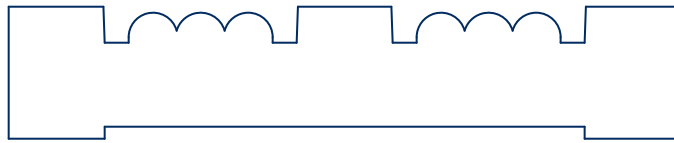

IL 280
11/16 x 3 1/2

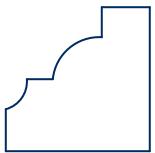

IL 264B
3/4 x 3/4



IL 276
3/4 x 3 5/8



IL 261B
5/8 x 11/16

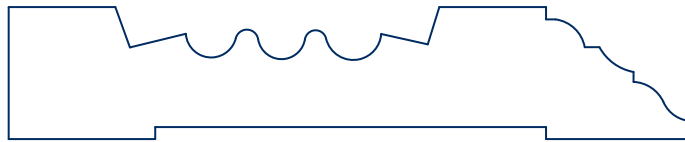

IL 261
11/16 x 3 9/16



IL 268B
11/16 x 13/16

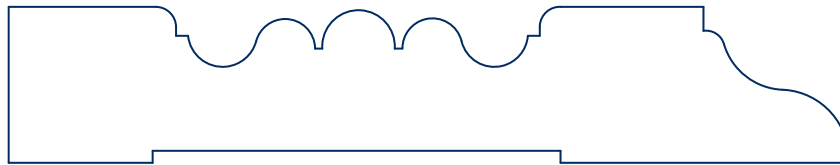

IL 268
13/16 x 4 3/8

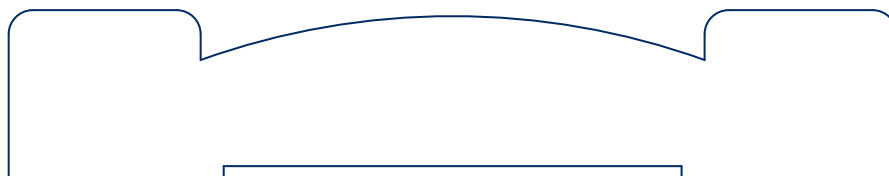

IL 263
7/8 x 4 5/8

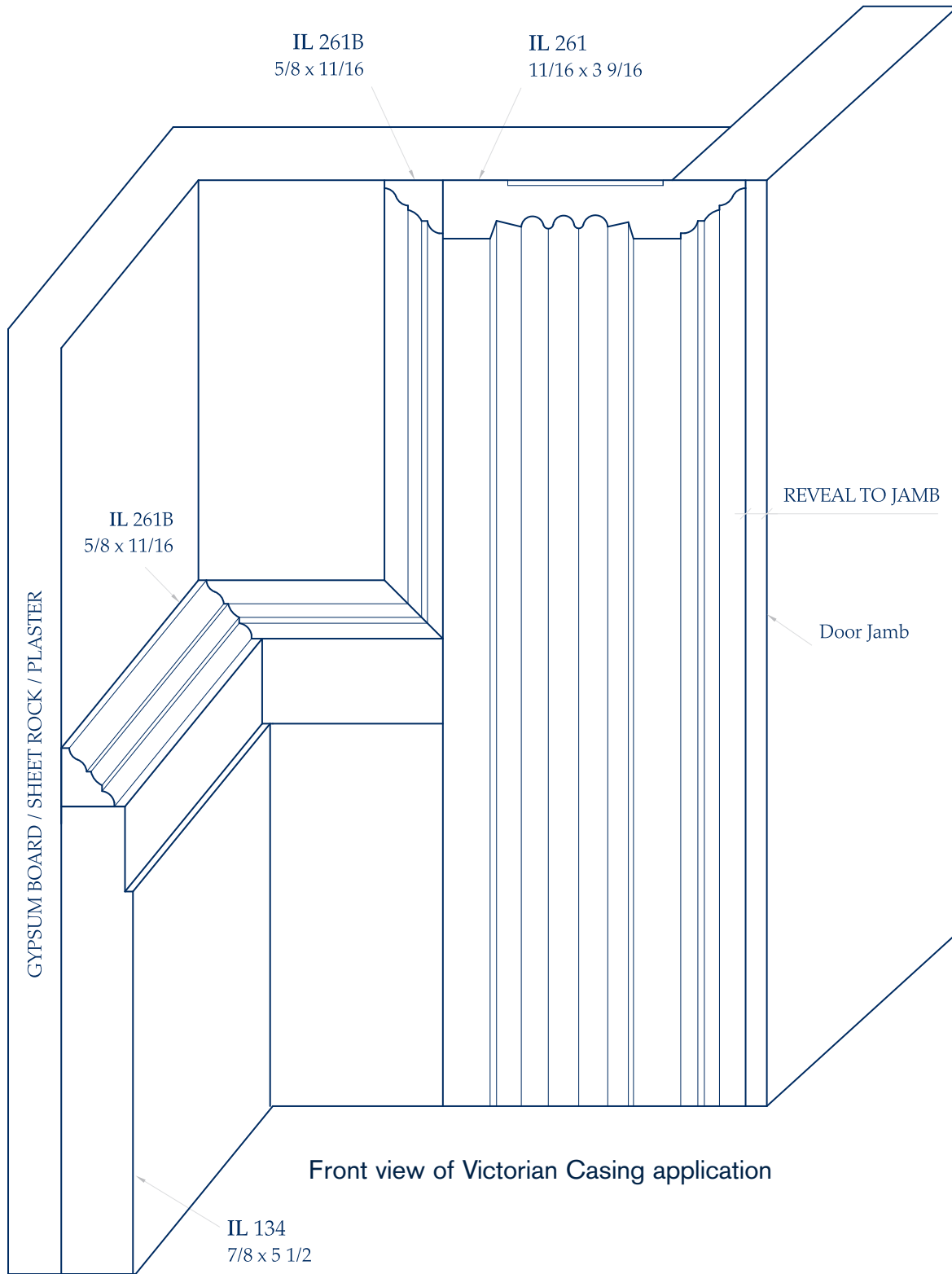

Profiles Shown 1:1

Greenwich, CT
203.531.8050 914.939.2500

Bethel, CT
203.748.5629

Newtown, CT
203.364.0074

Stamford, CT
203.348.3761

Croton Falls, NY
914.277.3603

Shrub Oak, NY
914.245.5050



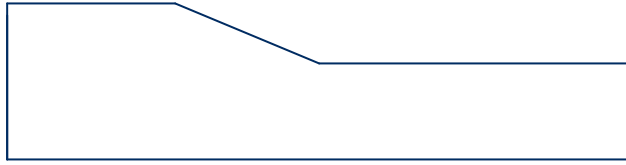

IL 207PB
13/16 x 3 1/4

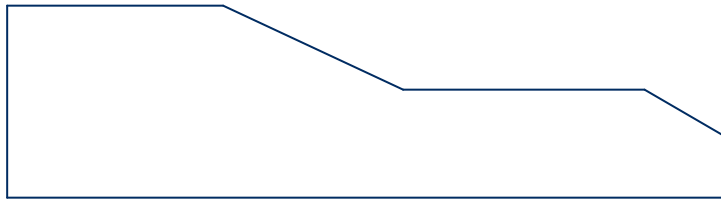

IL 2XXPB
1 x 3 3/4

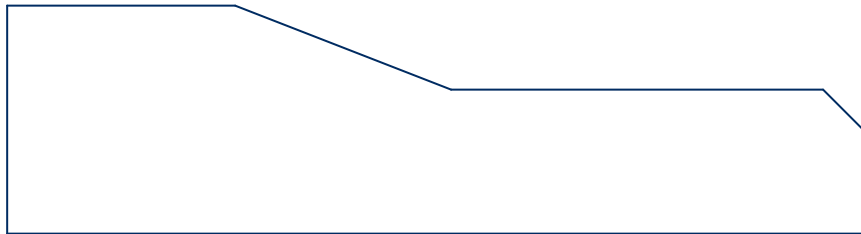

IL 224PB
1 3/16 x 4 1/2

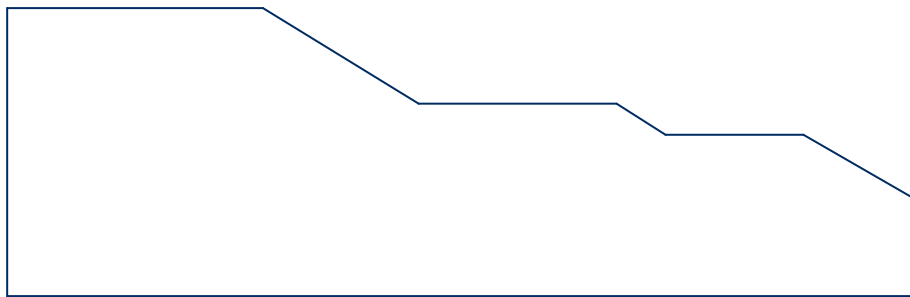

IL 219PB
1 1/2 x 4 3/4



IL QUIRK 1
1/2 x 1/2



IL QUIRK 2
3/4 x 3/4

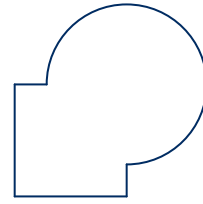

IL QUIRK 3
1 x 1

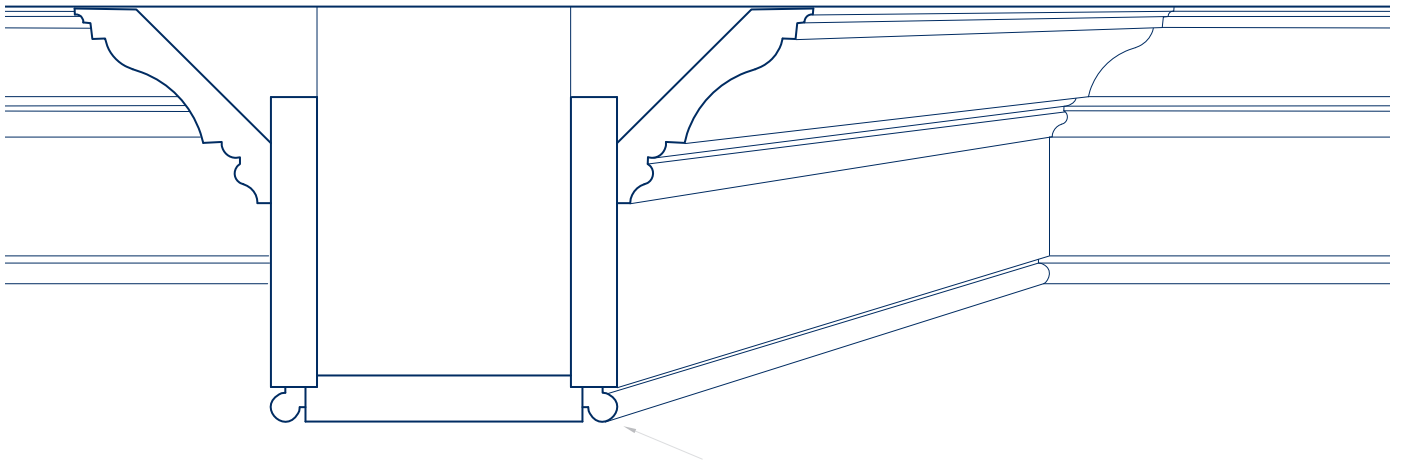

A Quirk Moulding is a decorative strip that may be used to finish a seam where two boards meet, creating a bead detail, as in the coffered ceiling example shown above.

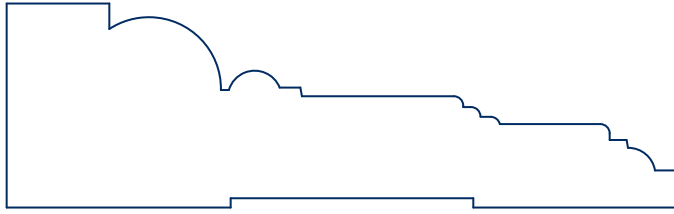

IL 289
1 1/16 x 3 1/2

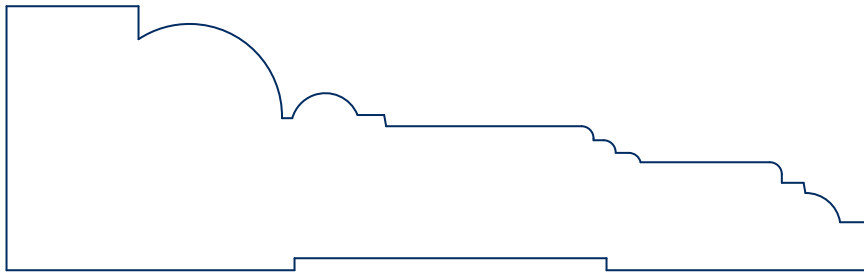

IL 219
1 3/8 x 4 1/2



IL 2006B
1 5/16 x 1 3/16

IL 2006
1 1/16 x 3 3/16

Overall Dimension = 4

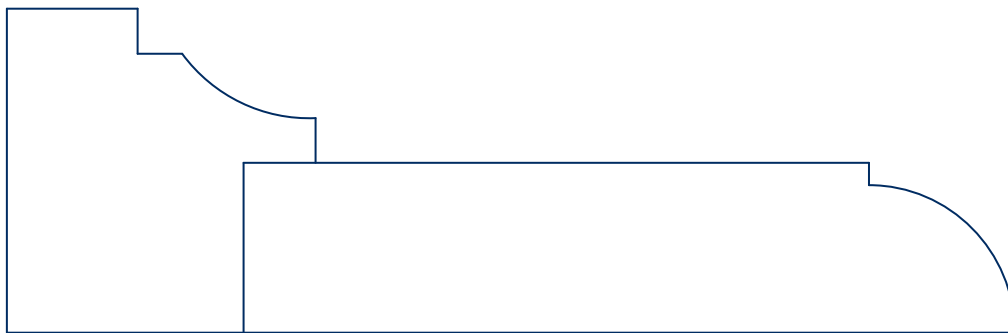

IL 2007B
1 11/16 x 1 5/8

IL 2007
7/8 x 4

Overall Dimension = 5 1/4